



art metal

K3 SYRIUSZ

F.P.H. Art Metal Sp.j.

Ul. Jabłoniowa 124, 83-331 Łapino Kartuskie, Poland
Tel. 0048 58 681 80 78, Fax: 0048 58 681 80 64
www.art-metal.pl e-mail: biuro@art-metal.pl

Construction:

The fixture includes a threaded base (1) to which a tray (9) with an igniter module (2) and a lampholder (3) is attached. The igniter is normally hidden under a protective cover fitted to the tray. A RASTER reflector (ODB-3) (5) can be used optionally. A bulb (6) is fitted into the lampholder. A threaded shade (7) is slid over the fixture and screwed into the female threaded base and, if appropriate, secured by set bolts.

Mounting instructions:

- *)- Attach the igniter (2) and the lampholder (3) to the base.
- lead the electrical cables out of the arm and place them neatly inside the fixture, connect them to the igniter (2).
- Place in position and attach the cover (4) of the igniter complete with the gasket (8).
- Attach the arm to the base (1).
- Put the bulb (6) in position.

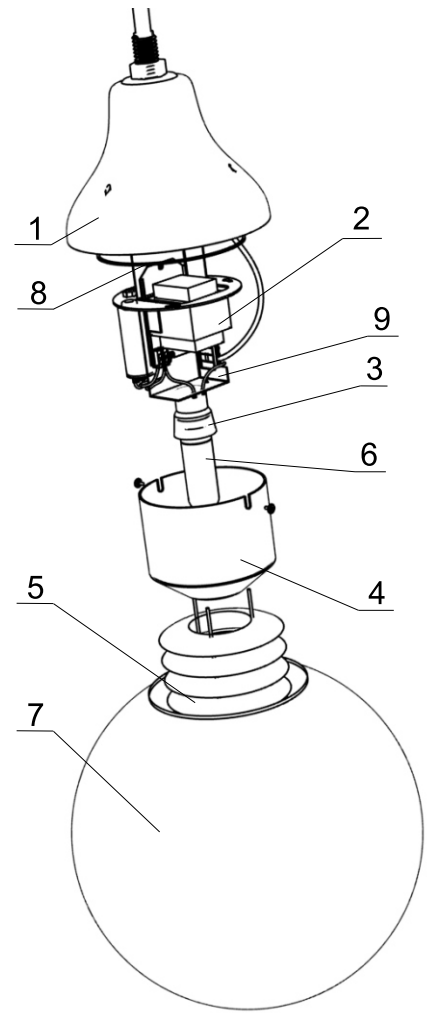

If any lantern elements are supplied factory-mounted, the mounting stages marked with *) should be omitted (as this has already been done by the manufacturer)

TECHNICAL DATA:

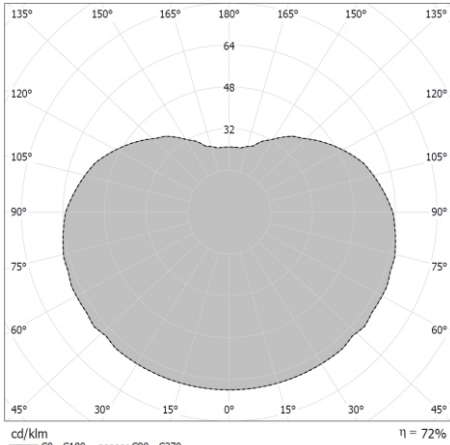

Photometry (polar plot)

Power: ~230/50Hz

Protective class: I

IP65 - electrical part

IP65 - optical part

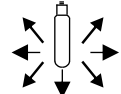
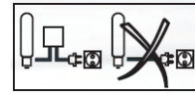
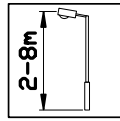

ELECTRICAL DIAGRAM:

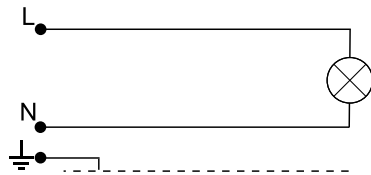

1. Incandescent bulb

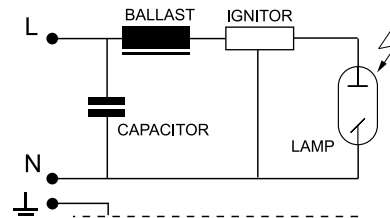

2. Sodium / metal halide lamps

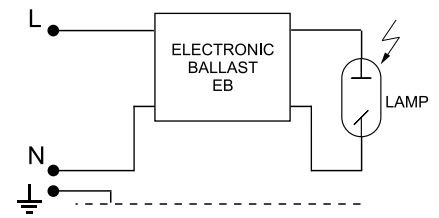

3. Sodium / metal halide lamps

Type	Light-producing element	Lamp holder	Weight [kg]	Pn [W]		Luminary dimensions
				IC	EB	
K3MH-70W	MH/HSI/HPI	E27	5,4	81	78	 Wind area A = 0,14m ² H/D 590/400
K3MH-100W	MH/HSI/HPI	E27	5,9	114	109	
K3S-70W	WLS/SHP/SON	E27	5,4	81	78	
K3S-100W	WLS/SHP/SON	E40	5,9	114	109	
K3Z-E/Z	Bulb / MINI - LINX	E27	3,9	Max. 60		

WARNING !! The weight of the unit may slightly differ for individual production batches.

